







Product Specification Guide

Stand-On Scales

	499KL	500KL	502KL	599KL	600KL/ELEVATE
					
FEATURES					
Capacity	460 lb / 209 kg	660 lb / 300 kg	660 lb / 300 kg	660 lb / 300 kg	660 lb / 300 kg
Resolution	0.2 lb / 0.1 kg	0.2 lb / 0.1 kg	0.2 lb / 0.1 kg	0.2 lb / 0.1 kg	0.2 lb / 0.1 kg
Height Rod Included		•	•		•
Display Size	1" / 25 mm	1" / 25 mm	1" / 25 mm	1" / 25 mm	1" / 25 mm
Wheels	•	•	•	•	•
EMR Capable		Optional	Optional	•	•
Power Adapter Included				•	•
Batteries Included	•	•	•		
Warranty (years)	2	2	2	2	2
Wireless Connectivity		Optional	Optional	Optional	Optional
PRODUCT DIMS (w x d x h)					
Platform Size	13 3/4" x 16 1/2" x 2 3/8"	13 3/4" x 16 1/2" x 2 3/8"	13 3/4" x 16 1/2" x 2 3/8"	14 1/4" x 14 1/4" x 2 5/8"	14 1/4" x 14 1/4" x 2 5/8"
Product Footprint	14 1/8" x 21 1/8" x 43 1/2"	14 1/8" x 21 1/8" x 53 5/8"	14 1/8" x 21 1/8" x 53 5/8"	14 3/4" x 23 1/4" x 42 1/2"	14 3/4" x 24 1/8" x 54 3/8"
Product Weight	21 lb / 9 kg	21 lb / 9 kg	22.4 lb / 10.2 kg	20 lb / 9 kg	28 lb / 13 kg
FUNCTIONS					
LB/KG Conversion	•	•	•	•	•
LB/KG Lockout	•	•	•	•	•
Hold/ Release	•	•	•	•	•
BMI	•	•	•	•	•
Zero	•	•	•	•	•
Tare	•	•	•	•	•
Pretare		•	•		
Auto Zero	•	•	•	•	•
Auto Off	•	•	•	•	•
Reweigh		•	•		
Recall		•	•		
Everlock®	•	•	•		
Parent/ Child Weighing	•	•	•	•	•
Variable Auto Off Time	•	•	•		
Audible/ Mute Sound	•	•	•		
Enabling Unit View		•	•		
ACCESSORIES (Optional)					
Power Adapter	ADPT31	ADPT31	ADPT31	ADPT50	ADPT50
Height Rod	499KLROD			499KLROD	
Wrap-Around Handlebar	499HB	500HB	500HB		
Wireless Kit		•	•	•	•
Wireless Printer		•	•	•	•

	1100KL	1110KL	2101KL	3001KL-AM	3001KL-AMX	3105KL-AM
FEATURES						
Capacity	1000 lb / 454 kg	1000 lb / 454 kg	1000 lb / 454 kg	1000 lb / 454 kg	1000 lb / 454 kg	1000 lb / 454 kg
Resolution	0.2 lb / 0.1 kg	0.2 lb / 0.1 kg	0.2 lb / 0.1 kg	0.2 lb / 0.1 kg	0.2 lb / 0.1 kg	0.2 lb / 0.1 kg
Display Size	1 ½" / 38 mm	1 ½" / 38 mm	1 ½" / 38 mm	1 ½" / 38 mm	1 ½" / 38 mm	1 ½" / 38 mm
Wheels	•		•	•	•	•
EMR Capable	•	•	•	•	•	•
Power Adapter Included	•	•	•	•	•	
Batteries Included						•
Warranty (years)	2	2	2	2	2	2
Antimicrobial				•	•	•
Antimicrobial Keypad	•	•	•	•	•	•
Wireless Connectivity	Optional	Optional	Optional	Optional	Optional	Optional
PRODUCT DIMS (w x d x h)						
Platform Size	22" x 15 ¾" x 2 ½"	22" x 15 ¾" x 2 ⅝"	26" x 22" x 2 ⅝"	22" x 15 ¾" x 2 ⅝"	22" x 15 ¾" x 2 ⅝"	19 ¾" x 21 ¼" x 2 ⅝"
Product Footprint	31 ¾" x 33 ½" x 49 ¾"	22" x 23 ½" x 4 ¾"	31" x 27" x 50"	22" x 34 ½" x 52"	22" x 34 ½" x 52"	23 ¼" x 28" x 52 ¼"
Product Weight	52 lb / 23 kg	27 lb / 12 kg	66 lb / 30 kg	42 lb / 19 kg	43 lb / 19.5 kg	86 lb / 39 kg
FUNCTIONS						
LB/KG Conversion	•	•	•	•	•	•
LB/KG Lockout	•	•	•	•	•	•
Hold/ Release	•	•	•	•	•	•
BMI	•	•	•	•	•	•
Zero	•	•	•	•	•	•
Tare	•	•	•	•	•	•
Pretare	•	•	•	•	•	•
Auto Zero	•	•	•	•	•	•
Auto Off	•	•	•	•	•	•
Reweigh	•	•	•	•	•	•
Recall	•	•	•	•	•	•
Everlock®	•	•	•	•	•	•
Parent/ Child Weighing	•	•	•	•	•	•
Time/ Date	•	•	•	•	•	•
Variable Auto Off Time	•	•	•	•	•	•
Audible/ Mute Sound	•	•	•	•	•	•
Enabling Unit View	•	•	•	•	•	•
ACCESSORIES (Optional)						
Power Adapter	ADPT30	ADPT30	ADPT30	ADPT30	ADPT30	ADPT30
Height Rod	PROPLUSROD or 245EHR-3105	201HR-1110 or 245EHR-1110	STROD or 245EHR-2101	3001HR or 245EHR-3001		201HR-3105 or 245EHR-3105
Wireless Kit	•	•	•	•	•	•
Wireless Printer	•	•	•	•	•	•

349KLX

498KL

752KL

2842KL



FEATURES

Capacity	400 lb / 180 kg	660 lb / 300 kg	660 lb / 300 kg	600 lb / 270 kg
Resolution	0.2 lb / 0.1 kg	0.2 lb / 0.1 kg	0.2 lb / 0.1 kg	0.2 lb / 0.1 kg
Display Size	1" / 25 mm	1" / 25 mm	1" / 25 mm	7/8" / 22 mm
EMR Capable		Optional	•	
Power Adapter Included			•	•
Batteries Included	•	•		
Warranty (years)	2	2	2	2
Wireless Connectivity		Optional	Optional	

PRODUCT DIMS (w x d x h)

Platform Size	12 1/2" x 12" x 1 7/8"	13 3/4" x 16 1/2" x 2 3/8"	14 1/4" x 14 1/4" x 2 5/8"	22 1/4" x 42" x 2 1/2"
Product Footprint	12 1/2" x 12" x 1 7/8"	13 3/4" x 16 1/2" x 2 3/8"	14 1/2" x 14 1/2" x 2 3/4"	22 1/4" x 42" x 2 1/2"
Product Weight	10 lb / 4.5 kg	14 lb / 6.4 kg	14 lb / 6.4 kg	53 lb / 24 kg





FUNCTIONS

LB/KG Conversion	•	•	•	•
LB/KG Lockout	•	•	•	
Hold/ Release	•	•	•	
BMI		•	•	
Zero	•	•	•	•
Tare	•	•	•	•
Pretare		•		
Auto Zero	•	•	•	
Auto Off	•	•	•	
Reweigh	•	•		
Recall				
Everlock®	•	•		
Parent/ Child Weighing	•	•	•	
Variable Auto Off Time	•	•		
Audible/ Mute Sound		•		
Enabling Unit View	•	•		

ACCESSORIES (Optional)

Power Adapter	ADPT40	ADPT31	ADPT50	ADPT31
Carrying Case	64771	64771	64771	
Wireless Kit		•	•	
Wireless Printer		•	•	

Mechanical Stand-On Scales

	400KL	402KL	402LB	402KG SPECIAL ORDER ONLY	450KL
					
FEATURES					
Capacity	390 lb / 180 kg	390 lb / 180 kg	400 lb	180 kg	500 lb / 200 kg
Graduation	¼ lb / 100 g	¼ lb / 100 g	¼ lb / 100 g	¼ lb / 100 g	¼ lb / 100 g
Height Rod Included		•	•	•	•
Rotating Poise Bars					•
Engraved Numerals					•
Warranty (years)	10	10	10	10	10
PRODUCT DIMS (w x d x h)					
Platform Size	10 ½" x 14" x 3 ¼"	10 ½" x 14" x 3 ¼"	10 ½" x 14" x 3 ¼"	10 ½" x 14" x 3 ¼"	10 ½" x 14" x 3 ¼"
Product Footprint	20 ¼" x 10 ⅝" x 57 ½"	20 ¼" x 10 ⅝" x 57 ½"	20 ¼" x 10 ⅝" x 57 ½"	20 ¼" x 14" x 57 ½"	20 ¼" x 14" x 57 ½"
Product Weight	24 lb / 11 kg	28 lb / 13 kg	28 lb / 13 kg	28 lb / 13 kg	31 lb / 14 kg
ACCESSORIES (Optional)					
Wheels	55000	55000	55000	55000	55000
Height Rod	402KLROD				
Counterweights	55090	55090			Included

Pediatric Scales

	522KL	524KL	549KL	550KL	553KL
					
FEATURES					
Capacity	50 lb / 23 kg	50 lb / 23 kg	44 lb / 20 kg	44 lb / 20 kg	44 lb / 20 kg
Resolution	0-20 lb / 0.2 oz; 20-50 lb / 0.5 oz; 0-9 kg / 5 g; 9-23 kg / 10 g	0-20 lb / 0.2 oz; 20-50 lb / 0.5 oz; 0-9 kg / 5 g; 9-23 kg / 10 g	0.5 oz / 10 g	0.5 oz / 10 g	0.5 oz / 10 g
Measuring Tape Included	•				•
Display Size	1" / 25 mm	1" / 25 mm	5/8" / 15 mm	1/2" / 13 mm	1" / 25 mm
EMR Capable	Optional	Optional			Optional
Batteries Included	•	•	•	•	•
Warranty (years)	2	2	2	2	2
Wireless Connectivity	Optional	Optional			Optional
PRODUCT DIMS (w x d x h)					
Tray/ Seat Size	24 1/8" x 14 1/2" x 2 5/8"	24 1/4" x 14 1/4" x 18 1/2"	19 3/8" x 12 1/8" x 2"	23 1/2" x 8" x 2"	24 7/8" x 13" x 1 3/8"
Product Footprint	24 1/8" x 21" x 23 1/8"	24 1/8" x 21" x 23 1/8"	19 3/8" x 13 1/2" x 4 3/8"	23 1/2" x 13 1/4" x 3 5/8"	24 7/8" x 16 1/2" x 3 7/8"
Product Weight	20 lb / 9 kg	21 lb / 10 kg	4 lb / 2 kg	8 lb / 4 kg	10 lb / 5 kg
FUNCTIONS					
LB/KG Conversion	•	•	•		•
LB/KG Lockout	•	•	•		•
Hold/ Release	•	•			•
Zero	•	•			•
Tare	•	•	•	•	•
Pretare	•	•			•
Auto Zero	•	•	•		•
Auto Off	•	•	•	•	•
Reweigh	•	•			•
Recall	•	•			•
Everlock®	•	•	•		•
Variable Auto Off Time	•	•	•		•
Audible/ Mute Sound	•	•			•
Enabling Unit View	•	•	•		•
Motion Detection	•	•	•		•
Auto Weight Hold	•	•	•	•	•
ACCESSORIES (Optional)					
Power Adapter	ADPT31	ADPT31			ADPT31
Carrying Case			64679	553CASE	553CASE
Height Rod	522EHR or 522HR			eBABYHR + 550EHRBRACKET	553HR or 553EHR
Cart			2210CART	2210CART	2210CART
Wireless Kit	•	•			•
Wireless Printer	•	•			•

565KL

2210KL-AM

2210KL4-AM

8320KL



FEATURES

Capacity	44 lb / 20 kg	45 lb / 20 kg / 20,000 gm	45 lb / 20 kg / 20,000 gm	33 lb / 15 kg
Resolution	0 – 44 lb x 0.1 oz / 0 – 6,000 g x 1 g / 6,001 g – 20,000 g x 2 g	1 g (to 10,000 g); 5 g (10,001 to 20,000 g)	1 g (to 10,000 g); 5 g (10,001 to 20,000 g)	0.5 oz / 10 g
Measuring Tape Included	•	•	•	
Display Size	¾" / 19 mm	1 ⅞" / 28 mm	1 ⅞" / 28 mm	¾" / 19 mm
EMR Capable	Optional	•	•	
Batteries Included	•	•	•	•
Warranty (years)	2	2	2	2
Antimicrobial		•	•	
Wireless Connectivity	Optional	Optional	Optional	

PRODUCT DIMS (w x d x h)

Tray/ Seat Size	24 ⅞" x 9 ⅞" x 2 ¼"	24" x 15 ¼" x 2 ¾"	26 ½" x 15 ¼" x 2 ¾"	23 ½" x 11" x ⅞"
Product Footprint	26 ¼" x 13" x 5 ¼"	24 ¾" x 17 ¾" x 6"	26 ½" x 17 ¾" x 6"	29 ⅞" x 12 ⅞" x 2 ⅞"
Product Weight	9 lb / 4.1 kg	28 lb / 13 kg	28 lb / 13 kg	5 lb / 3 kg

FUNCTIONS

LB/KG Conversion	•	•	•	•
LB/KG Lockout	•	•	•	
Hold/ Release	•	•	•	
Zero	•	•	•	•
Tare	•	•	•	
Pretare	•	•	•	
Auto Zero	•	•	•	•
Auto Off	•	•	•	•
Reweigh	•	•	•	
Recall	•	•	•	
Everlock®	•	•	•	
Variable Auto Off Time	•	•	•	
Audible/ Mute Sound	•	•	•	
Enabling Unit View	•	•	•	
Motion Detection	•	•	•	
Auto Weight Hold	•	•	•	
Breast Milk Intake		•	•	

ACCESSORIES (Optional)

Power Adapter	69-00001	ADPT30	ADPT30	
Carrying Case				64771
Height Rod	565EHR	2210EHR		
Cart	2210CART	2210CART-AC	2210CART-AC	
Wireless Kit	•	•	•	
Wireless Printer	•	•	•	

1522KL

1524KL

386S-01

386KGS-01

BABYSLINGSCALE



FEATURES





Capacity	135 lb / 62 kg	130 lb / 65 kg	50 lb	25 kg	25 kg
Graduation	1 oz / 20 g	1 oz / 20 g	¼ lb	100 g	100 g
Measuring Tape Included	•		•	•	
Dial Size			3" / 76 mm	3" / 76 mm	5 ½" / 140 mm
Warranty (years)	2	2	1	1	1

PRODUCT DIMS (w x d x h)

Tray/ Seat Size	24" x 16 ½" x 2 ⅞"	24 ½" x 14 ¼" x 18 ½"	19 ⅜" x 12 ⅜" x 3 ¾"	19 ⅜" x 12 ⅜" x 3 ¾"	
Product Footprint	24" x 20" x 22 ½"	24 ½" x 21" x 22 ½"	19 ⅜" x 14 ½" x 5 ⅛"	19 ⅜" x 14 ½" x 5 ⅛"	12" x 43" x 1 ⅞"
Product Weight	25 lb / 11 kg	32 lb / 15 kg	10 lb / 5 kg	10 lb / 5 kg	2 lb / 1 kg

Wheelchair & Chair Scales

	2500KL	2600KL	2610KL	2650KL	2700KL	2900KL-AM
						
FEATURES						
Capacity	1000 lb / 454 kg	1000 lb / 454 kg	1000 lb / 454 kg	1000 lb / 454 kg	1000 lb / 454 kg	1000 lb / 454 kg
Resolution	0.2 lb / 0.1 kg	0.2 lb / 0.1 kg	0.2 lb / 0.1 kg	0.2 lb / 0.1 kg	0.2 lb / 0.1 kg	0.2 lb / 0.1 kg
Display Size	1 1/2" / 38 mm	1 1/2" / 38 mm	1 1/2" / 38 mm	1 1/2" / 38 mm	1 1/2" / 38 mm	1 1/2" / 38 mm
Wheels	•	•	•	•	•	
EMR Capable	•	•	•	•	•	•
Power Adapter Included	•	•	•	•	•	•
Warranty (years)	2	2	2	2	2	2
Antimicrobial						•
Antimicrobial Keypad	•	•	•	•	•	•
Wireless Connectivity	Optional	Optional	Optional	Optional	Optional	Optional
PRODUCT DIMS (w x d x h)						
Platform Size	29 3/8" x 28 1/4" x 2 3/8"	36" x 32 1/4" x 2 1/2"	36" x 32 1/4" x 2 1/2"	31 1/2" x 31 1/2" x 2"	43" x 42" x 2 1/2"	29 1/2" x 32 1/2" x 2 3/4"
Product Footprint	40 1/4" x 34 1/2" x 45 1/2"	48 1/8" x 43 7/8" x 49 3/8"	56 3/4" x 43 7/8" x 49 3/8"	51 3/4" x 33 5/8" x 5 1/4"	69 1/8" x 51 1/2" x 3 3/8"	58" x 37" x 37"
Product Weight	81 lb / 37 kg	93 lb / 42 kg	98 lb / 44 kg	82 lb / 37 kg	187 lb / 85 kg	91 lb / 41 kg
FUNCTIONS						
LB/ KG Conversion	•	•	•	•	•	•
LB/ KG Lockout	•	•	•	•	•	•
Hold/ Release	•	•	•	•	•	•
BMI	•	•	•	•	•	•
Zero	•	•	•	•	•	•
Tare	•	•	•	•	•	•
Pretare	•	•	•	•	•	•
Auto Zero	•	•	•	•	•	•
Auto Off	•	•	•	•	•	•
Reweigh	•	•	•	•	•	•
Recall	•	•	•	•	•	•
Everlock®	•	•	•	•	•	•
Time/ Date	•	•	•	•	•	•
Parent/ Child Weighing	•	•	•	•	•	•
Variable Auto Off Time	•	•	•	•	•	•
Audible/ Mute Sound	•	•	•	•	•	•
Enabling Unit View	•	•	•	•	•	•
ACCESSORIES (Optional)						
Power Adapter	ADPT30	ADPT30	ADPT30	ADPT30	ADPT30	ADPT30
Wireless Kit	•	•	•	•	•	•
Wireless Printer	•	•	•	•	•	•
Ramp	B2500RAMP	B2600RAMP				

	2400KL	2500CKL	2595KL	594KL	445KL
FEATURES					
Capacity	800 lb / 363 kg	1000 lb / 454 kg	600 lb / 270 kg	600 lb / 270 kg	440 lb / 200 kg
Resolution	0.2 lb / 0.1 kg	0.2 lb / 0.1 kg	0.2 lb / 0.1 kg	0.2 lb / 0.1 kg	0.2 lb / 0.1 kg
Display Size	1 ½" / 38 mm	1 ½" / 38 mm	1 ½" / 30 mm	1" / 25 mm	
Wheels	•	•	•	•	•
EMR Capable	•	•	•		
Power Adapter Included	•	•	•	•	
Warranty (years)	2	2	2	2	2
Antimicrobial Keypad	•	•			
Wireless Connectivity	Optional	Optional			
PRODUCT DIMS (w x d x h)					
Platform Size	25 ¾" - 50 ⅞"	29 ⅜" x 28 ¼" x 2 ⅜"			
Seat Size		18" x 15"	18 ¼" x 15 ¾"	18" x 18 ½"	18" x 17 ¼"
Product Footprint	51 ¼" x 40 ½" x 3 ½"	40 ¼" x 34 ½" x 45 ½"	23 ½" x 37 ½" x 39 ⅞"	23 ¼" x 40 ⅞" x 37 ⅞"	24 ¾" x 31 ⅝" x 39 ⅞"
Product Weight	40 lb / 18 kg	121 lb / 55 kg	84 lb / 38 kg	39 lb / 18 kg	60 lb / 27 kg
FUNCTIONS					
LB/ KG Conversion	•	•	•	•	
LB/ KG Lockout	•	•	•	•	
Hold/ Release	•	•		•	
BMI	•	•		•	
Zero	•	•	•	•	
Tare	•	•		•	
Pretare	•	•			
Auto Zero	•	•		•	
Auto Off	•	•	•	•	
Reweigh	•	•	•		
Recall	•	•			
Everlock®	•	•			
Time/ Date	•	•			
Parent/ Child Weighing	•	•			
Variable Auto Off Time	•	•			
Audible/ Mute Sound	•	•			
Enabling Unit View	•	•			
ACCESSORIES (Optional)					
Power Adapter	ADPT30	ADPT30	ADPT30	ADPT30	
Wireless Kit	•	•			
Wireless Printer	•	•			
Ramp		B2500RAMP			

Body Composition Scales

FEATURES

Capacity	1000 lb / 454 kg
Resolution	0.2 lb / 0.1 kg
Body Fat Accuracy	+/- 2%
Measurement Time	15 seconds
Power Adapter Included	•
6 Window Display	•
Limited Test Restrictions	•
OHMS Modulation Logic	•
Warranty (years)	1

MEASUREMENTS

Weight	•
% Body Fat	•
% Body Water	•
% Muscle Mass	•
BMI (OR BMI %)	•
REE/ BMR	•
Activity-Based Caloric Burn Rate	•

IMPACT ON ACCURACY/ PRE-TEST RESTRICTIONS

Recent Food/ Drink	OK to Test
Recent Exercise	OK to Test
Full Night Sleep	OK to Test
Recent Alcohol Intake	OK to Test
Full Bladder	OK to Test

REPORTS

Plain Paper	•
Illustrated	•
Off-the-Shelf Printer	•

PRODUCT DIMS (w x d x h)





Platform Size	14" x 16" x 2 7/8"
Product Footprint	18" x 23 1/2" x 41 1/4"
Product Weight	27 lb / 12 kg

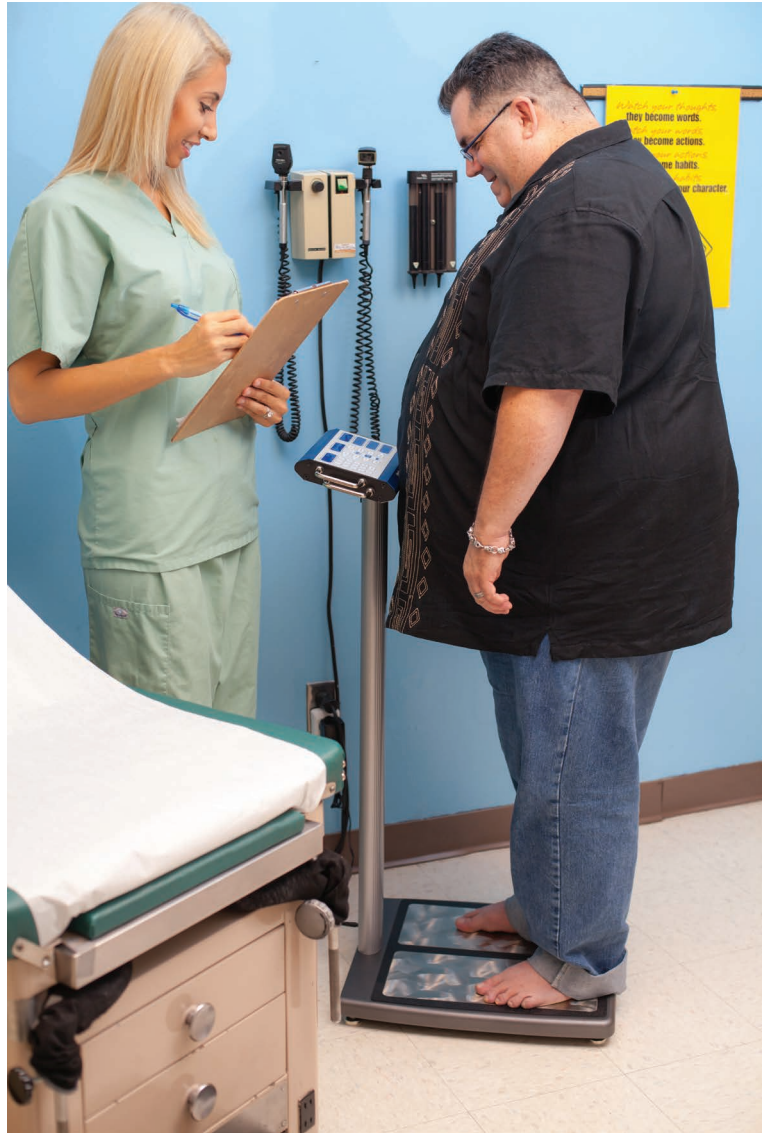



USAGE

	BCS-G6-adult	BCS-G6-limbs	BCS-G6-DUO	BCS-G61-upper
Adult Patients	•	•	•	•
Pediatric Patients			•	
Segmented (Incl. Arms & Legs)		•		
Upper Body Only				•
Shoes OK				•







Professional Home Care Scales

	800KL	810KL	880KL	844KL	822KL
					
FEATURES					
Capacity	397 lb / 180 kg	440 lb / 200 kg	500 lb / 220 kg	440 lb / 200 kg	400 lb / 180 kg
Resolution	0.2 lb / 0.1 kg	0.2 lb / 0.1 kg	0.2 lb / 0.1 kg	0.1 lb / 0.05 kg	0.1 lb / 0.05 kg
Display Size	1 1/2" / 38 mm	1 7/8" / 48 mm	1 7/8" / 48 mm	1 1/4" / 32 mm	1 1/2" / 38 mm
Batteries Included	•	•	•	•	•
Case Pack Quantity	4	1	4	2	2
Warranty (years)	1	1	1	1	1
PRODUCT DIMS (w x d x h)					
Platform Size	12 1/4" x 12 1/4" x 1 3/4"	13" x 13" x 7/8"	17" x 13" x 1 1/4"	12 5/8" x 12 5/8" x 1 7/8"	14 1/4" x 11 3/4" x 1 1/2"
Product Footprint	12 1/4" x 12 1/4" x 1 3/4"	13" x 13" x 7/8"	17" x 13" x 1 1/4"	12 5/8" x 12 5/8" x 1 7/8"	14 1/4" x 11 3/4" x 1 3/4"
Product Weight	4 lb / 2 kg	4 lb / 2 kg	8 lb / 4 kg	4 lb / 2 kg	4 lb / 2 kg
FUNCTIONS					
LB/ KG Conversion		•			
Auto Zero	•	•	•	•	•
Auto Off	•	•	•	•	•
5 Second Weight Hold		•			
ACCESSORIES (Optional)					
Carrying Case	64771		64769	64771	64771





	142KL	160KL	160LB	160KG
				
FEATURES				
Capacity	330 lb / 150 kg	400 lb / 180 kg	400 lb	180 kg
Resolution	1 lb / 0.5 kg	1 lb / 1 kg	1 lb	1 kg
Dial Size	6 1/2" / 165 mm	8" / 203 mm	8" / 203 mm	8" / 203 mm
Case Pack Quantity	2	2	2	2
Warranty (years)	1	1	1	1
PRODUCT DIMS (w x d x h)				
Platform Size	11 1/2" x 10 3/4" x 2 1/4"	11" x 12 1/2" x 3"	11" x 12 1/2" x 3"	11" x 12 1/2" x 3"
Product Footprint	11 3/4" x 17 3/8" x 3 1/2"	11 3/4" x 18 1/4" x 7 1/4"	11 3/4" x 18 1/4" x 7 1/4"	11 3/4" x 18 1/4" x 7 1/4"
Product Weight	6 lb / 3 kg	9 lb / 4 kg	9 lb / 4 kg	9 lb / 4 kg

	100LB	100KG	175LB
			
FEATURES			
Capacity	270 lb	120 kg	330 lb
Resolution	1 lb	1 lb	1 lb
Dial Size	2" / 51 mm	2" / 51 mm	3 1/2" / 89 mm
Case Pack Quantity	3	3	2
Warranty (years)	1	1	1
PRODUCT DIMS (w x d x h)			
Platform Size	10 1/4" x 10" x 1 7/8"	10 1/4" x 10" x 1 7/8"	10 1/2" x 9 3/8" x 2"
Product Footprint	10 1/4" x 10" x 2"	10 1/4" x 10" x 2"	11 3/8" x 9 3/4" x 2 1/4"
Product Weight	4 lb / 2 kg	4 lb / 2 kg	4 lb / 2 kg
ACCESSORIES (Optional)			
Carrying Case	64771	64771	64771

Specialty Scales











	PTS-1000KL	2000KL	3400KL	3401KL	YG500R
					
FEATURES					
Capacity	550 lb / 250 kg	400 lb / 181 kg	176 oz / 5000 g	176 oz / 5000 g	500 g
Resolution/ Graduation	1 lb / 0.5 kg	0.2 lb / 0.1 kg	0.05 oz / 1 g	0.05 oz / 1 g	2 g
Display/ Dial Size	1" / 25 mm	1 ½" / 38 mm	¾" / 16 mm	¾" / 16 mm	6" / 152 mm
Wheels		•			
EMR Capable		•			
Power Adapter Included	•	•	•	•	
Warranty (years)	2	2	2	2	1
Wireless Connectivity		Optional			
PRODUCT DIMS (w x d x h)					
Platform Size	71" x 21"	70 ½" x 30"	9 ½" x 11 ¾" x 2 ½"	7 ¾" x 9 ¾" x 5 ½"	6 ½" x 4 ¾"
Product Footprint	71" x 27 ½" x 1"	70 ½" x 46 ½" x 60 ½"	10 7/8" x 13" x 8"	10" x 11 ¾" x 5 ¾"	6 ½" x 6 7/8" x 8 5/8"
Product Weight	25 lb / 11.4 kg	104 lb / 47 kg	11 lb / 5 kg	10 lb / 4.5 kg	3 lb / 1 kg
FUNCTIONS					
LB/ KG Conversion	•	•	•	•	
LB/ KG Lockout		•			
Hold/ Release	•	•			
BMI		•			
Zero		•	•	•	
Tare		•	•	•	
Pretare		•			
Auto Zero		•	•	•	
Auto Off	•	•	•	•	
Reweigh		•			
Recall		•			
Everlock®		•			
Time/ Date		•			
Variable Auto Off Time		•			
Audible/ Mute Sound		•			
Enabling Unit View		•			
ACCESSORIES (Optional)					
Power Adapter	69-00012	APT30	3400ADPT	3400ADPT	
Wireless Kit		•			
Wireless Printer		•			
Other			3400PAN (3 pack pans) 3400TRAY (3 pack trays)	3400PAN (3 pack pans) 3400TRAY (3 pack trays)	



Height Measuring Instruments

	201HR	205HR	PORTROD	WMROD
FEATURES				
Measurement Range	2" - 90" / 6 - 230 cm	0 - 90" / 0 - 230 cm	24" - 83" / 60 - 213 cm	11 7/8" - 84" / 30 - 213 cm
Graduation	1/16" / 1 mm	1/16" / 1 mm	1/16" / 1 mm	1/8" / 1 mm
Warranty (years)	2	2	2	2
PRODUCT DIMS (w x d x h)				
Product Footprint	2 1/4" x 11" x 54"	2 5/8" x 8" x 60"	2 3/4" x 8 1/4" x 60"	1 1/2" x 13 1/2" x 80 1/4"
Product Weight	2 lb / 1 kg	2 lb / 1 kg	1 lb / .5 kg	4.2 lb / 2 kg

	221HR	280HR	BABYHR	EBABYHR
FEATURES				
Measurement Range	7" - 82.6" / 17.7 - 210 cm	3.9 - 43.3" / 10 - 110 cm	3" - 39" / 7 - 100 cm	13 3/4" - 31 1/2" / 35 - 80 cm
Graduation	1/16" / 1 mm	1/4" / 5 mm	1/16" / 1 mm	1/16" / 1 mm
Warranty (years)	2	2	2	2
PRODUCT DIMS (w x d x h)				
Product Footprint	13 3/4" x 23" x 89"	55" x 12"	1 1/2" x 11 1/4" x 41"	2 3/4" x 11 1/2" x 24 3/4"
Product Weight	7.9 lb / 3.6 kg	.88 lb / .4 kg	1 lb / .5 kg	1 lb / .5 kg

Height Measuring Accessories for Platform Scales

	Height Rods for 1100KL Series	Height Rods for 1110KL Series	Height Rods for 2101KL Series	Height Rods for 3001KL-AM Series	Height Rods for 3105KL-AM Series
	PROPLUSROD	201HR-1110	STROD	3001HR	201HR-3105
					
FEATURES					
Mechanical Measurement Range	2" - 90" / 6 - 230 cm	2" - 90" / 6 - 230 cm	2" - 90" / 6 - 230 cm	2" - 90" / 6 - 230 cm	2" - 90" / 6 - 230 cm
Mechanical Measurement Graduation	1/16" / 1 mm	1/16" / 1 mm	1/16" / 1 mm	1/16" / 1 mm	1/16" / 1 mm
Warranty (years)	2	2	2	2	2
PRODUCT DIMS (w x d x h)					
Product Footprint	2 ¼" x ¾" x 54"	2 ¼" x ¾" x 54"	2 ¼" x ¾" x 54"	2 ¼" x ¾" x 54"	2 ¼" x ¾" x 54"
Product Weight	2 lb / 1 kg	2 lb / 1 kg	2 lb / 1 kg	2 lb / 1 kg	2 lb / 1 kg
	245EHR-1100	245EHR-1110	245EHR-2101	245EHR-3001	245EHR-3105
					
FEATURES					
Mechanical Measurement Range	11 ¾" - 79 ½" / 30 - 202 cm	11 ¾" - 79 ½" / 30 - 202 cm	11 ¾" - 79 ½" / 30 - 202 cm	11 ¾" - 79 ½" / 30 - 202 cm	11 ¾" - 79 ½" / 30 - 202 cm
Mechanical Measurement Graduation	1/16" / 1 mm	1/16" / 1 mm	1/16" / 1 mm	1/16" / 1 mm	1/16" / 1 mm
Digital Measurement Range	3 ft. 11.2" - 6 ft. 7.5" / 120 cm - 202 cm	3 ft. 11.2" - 6 ft. 7.5" / 120 cm - 202 cm	3 ft. 11.2" - 6 ft. 7.5" / 120 cm - 202 cm	3 ft. 11.2" - 6 ft. 7.5" / 120 cm - 202 cm	3 ft. 11.2" - 6 ft. 7.5" / 120 cm - 202 cm
Digital Measurement Resolution	0.1" / 1 mm	0.1" / 1 mm	0.1" / 1 mm	0.1" / 1 mm	0.1" / 1 mm
Warranty (years)	2	2	2	2	2
PRODUCT DIMS (w x d x h)					
Product Footprint	2 ¼" x 2" x 48"	2 ¼" x 2" x 48"	2 ¼" x 2" x 48"	2 ¼" x 2" x 48"	2 ¼" x 2" x 48"
Product Weight	4 lb / 2 kg	4 lb / 2 kg	4 lb / 2 kg	4 lb / 2 kg	4 lb / 2 kg

	Height Rod for 400KL Series	Height Rod for 499KL & 599KL Series
	402KLROD	499KLROD
		
FEATURES		
Mechanical Measurement Range	11 7/8" - 84" / 30 - 213 cm	11 7/8" - 84" / 30 - 213 cm
Mechanical Measurement Graduation	1/8" / 1 mm	1/8" / 1 mm
Warranty (years)	2	2
PRODUCT DIMS (w x d x h)		
Product Footprint	1 ½" x 13 ½" x 80 ¼"	1 ½" x 13 ½" x 80 ¼"
Product Weight	4.2 lb / 2 kg	4.2 lb / 2 kg

Height Measuring Accessories for Pediatric Scales

	Height Rods for 522KL Series	Height Rods for 553KL Series	Height Rod for 550KL	Height Rod for 565KL Series	Height Rod for 2210KL-AM Series
	522EHR	553EHR	eBABYHR + 550EHRBRACKET	565EHR	2210EHR
					
FEATURES					
Digital Measurement Range	13 3/4" - 31 1/2" / 35 cm - 80 cm	13 3/4" - 31 1/2" / 35 cm - 80 cm	13 3/4" - 31 1/2" / 35 cm - 80 cm	13 3/4" - 31 1/2" / 35 cm - 80 cm	13 3/4" - 31 1/2" / 35 cm - 80 cm
Digital Measurement Resolution	1/16" / 0.1 cm	1/16" / 0.1 cm	1/16" / 0.1 cm	1/16" / 0.1 cm	1/16" / 0.1 cm
Warranty (years)	2	2	2	2	2
PRODUCT DIMS (w x d x h)					
Product Footprint	2 3/4" x 11 1/2" x 24 3/4"	2 3/4" x 11 1/2" x 24 3/4"	2 3/4" x 11 1/2" x 24 3/4"	2 3/4" x 11 1/2" x 24 3/4"	2 3/4" x 11 1/2" x 24 3/4"
Product Weight	2 lb / 1 kg	2 lb / 1 kg	2 lb / 1 kg	2 lb / 1 kg	2 lb / 1 kg
	522HR	553HR			
					
FEATURES					
Mechanical Measurement Range	3" - 39" / 7 - 100 cm	3" - 39" / 7 - 100 cm			
Mechanical Measurement Graduation	1/16" / 1 mm	1/16" / 1 mm			
Warranty (years)	2	2			
PRODUCT DIMS (w x d x h)					
Product Footprint	1 1/2" x 11 1/4" x 41"	1 1/2" x 11 1/4" x 41"			
Product Weight	1 lb / .5 kg	1 lb / .5 kg			